



SKU: BF4268

-  PVC Butterfly Valve – Lever Operated
-  PVC Absperrklappe - Hebel
-  La válvula de mariposa en PVC - palanca accionada

Valves[™]
O N L I N E

- 2" - 8" PVC Wafer Butterfly Valve – PN10/16
- 2" - 8" PVC- Wafer-Klappe - PN10 / 16
- 2" - 8" válvula de mariposa Wafer PVC - PN10 / 16

STANDARD SERIES PVC Butterfly Valve



Description

Butterfly valve, PVC-U body,, Liner in EPDM or Viton Zinc plated steel shaft, Disc in PVC-U, PP handle



Beschreibung

Absperrklappe , PVC-U Gehäuse , Blauer farbepunkt, EPDM, Achse Stahl verzinkt , Disc in PVC-U, PP Griff





Descripción

Válvula de mariposa , PVC - U cuerpo , punto azul , Juntas EPDM , Eje en acero zincado , Compuerta de PVC - U, mango PP

- **Standard Series**
- **PVC Body**
- **Fits between PN10 / 16 Flanges**
- **Liner EPDM or Viton**
- **Ratchet Lever in PP**

PVC Standard Butterfly is ideally suited for flow control using minimal pipe space. The valve offers excellent flow characteristics and minimal pressure drop. Good mechanical strength and resistance to many inorganic chemicals, it is available from 2" up to 8" and supplied with lever handle with ratchet hold.

-  PVC Butterfly Valve – Lever Operated
-  PVC Absperrklappe - Hebel
-  La válvula de mariposa en PVC - palanca accionada

PVC Lever Operated Butterfly Valve

Butterfly valve, PVC-U body, Blue dot, Joint in EPDM or Viton. Zinc plated steel shaft, Disc in PVC-U, PP handle

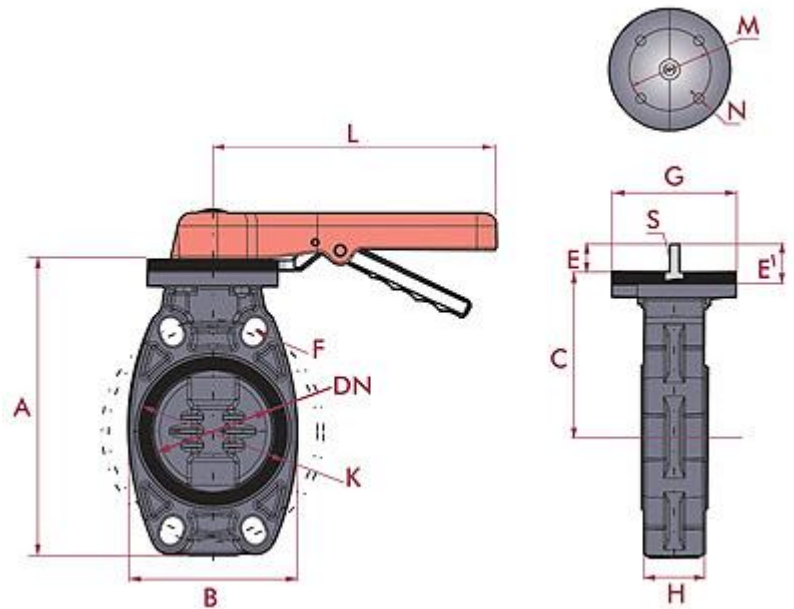

DIMENSIONS FOR STANDARD PVC BUTTERFLY VALVE

| Size | A | B | C | E | F | G | H | K | L | M | N | E' | S | Wt (kg) |
|--------|-----|-----|-----|----|----|-----|----|-----|-----|-----|----|----|----|---------|
| 2" | 201 | 135 | 120 | 40 | 18 | 112 | 48 | 125 | 220 | 70 | 9 | 35 | 10 | 1.65 |
| 2 1/2" | 201 | 135 | 120 | 40 | 18 | 112 | 48 | 125 | 220 | 70 | 9 | 35 | 10 | 1.65 |
| 3" | 232 | 122 | 136 | 40 | 19 | 112 | 52 | 170 | 245 | 70 | 9 | 35 | 12 | 1.9 |
| 4" | 255 | 145 | 148 | 40 | 19 | 112 | 59 | 192 | 245 | 70 | 9 | 35 | 16 | 2.6 |
| 5" | 284 | 175 | 164 | 40 | 22 | 112 | 66 | 215 | 320 | 70 | 9 | 35 | 20 | 3.5 |
| 6" | 314 | 209 | 180 | 40 | 24 | 112 | 72 | 240 | 320 | 70 | 9 | 35 | 20 | 4.35 |
| 8" | 378 | 248 | 217 | 40 | 23 | 136 | 73 | 298 | 391 | 102 | 11 | 47 | 26 | 7.35 |

Butterfly Valve

| Size | DN | D | PN |
|--------|-----|---------|----|
| 2" | 65 | 63-75 | 10 |
| 2 1/2" | 65 | 63-75 | 10 |
| 3" | 80 | 90 | 10 |
| 4" | 100 | 110 | 10 |
| 5" | 125 | 125-140 | 10 |
| 6" | 150 | 160 | 10 |
| 8" | 200 | 200-225 | 10 |