



2/2-way Angle-Seat Valve with stainless steel design for medium up to +185 °C, DN 15-65

- High flow rates
- High cycle life
- Flow optimised body in stainless steel
- Deliverable with flow direction below or above seat
- Clean design for optimal use in hygienic environment
- Suitable for steam up to 10 bar(g)

Type 2100 welded can be combined with...



Type 8691
Control Head



Type 8695
Control Head



Type 8690
Pneumatic Control Unit



Type 8697
Pneumatic Control Unit



Type 8619
MultiCELL Transmitter/Controller



Type 8222
Conductivity transmitter

In line with Bürkert's philosophy for modular valves and sensors the construction of the 2100 angle-seat valve fulfils tough criteria for process environments. Unrivalled cycle life and sealing integrity is guaranteed by the proven self adjusting spindle packing with V-seals.

The design enables the easy integration of automation modules whether they are electrical/optical position feedback, pneumatic control units, an integrated fieldbus interface.

The fully integrated system has a compact and smooth design, integrated pneumatic lines, IP65/67 protection class and superior chemical resistance.

An explosion-proof version is also available.

Technical data	
Orifice	DN15 to DN65
Port connections	EN ISO 1127/ISO 4200, DIN 11850 S2, ASME BPE, SMS 3008, BS 4825
Welded acc. to	see separate data sheet
Clamp and threaded	
Body material	Stainless steel 316L
EN ISO 1127/ISO4200 and DIN 11850 S2	
ASME BPE, SMS 3008 and BS 4825 Part 1	
Nominal pressure	PN25 (Body)
Actuator material	PPS / Stainless steel 1.4561 (316Ti)
Actuator / Cover	
Sealing material	PTFE
Medium	Water, alcohol, oils, fuels, hydraulic fluids, salt solution, alkali solutions, organic solvents, steam, optional fuel gas (EC Gas Appliances Directive 2009/142/EG)
Viscosity	max. 600 mm ² /s
Spindle packing	PTFE V-rings with spring compensation
Medium temperature	-10 to +185 °C
Ambient temperature	0 to +55 °C (integrated control head) 0 to +60 °C (push-in air ports) 0 to +100 °C (threaded air ports)
Control medium	Neutral gases, air
Max. pilot pressure	max. 10 bar; actuator size 130 mm, 7 bar
Pilot air ports	Push-in connector for external ø 6 mm or 1/4" tube, thread G1/8 (on request)
Installation	As required, preferably with actuator in upright position
Surface Finish	Int. Ra ≤ 3.2 µm (internal connection area Ra ≤ 0.6 µm mech. or electropolished (external cast surface) on request)

Content

Valve specifications	System spec. On/Off ELEMENT	Request for quotation
Type 2100	Type 8801-YE	Type 8801-YE
Technical data & ordering info. p. 1-9	Technical data & ordering info. p. 10-14	p.16

Technical data angle seat valve Type 2100 flow direction below the seat (for gases and liquids)

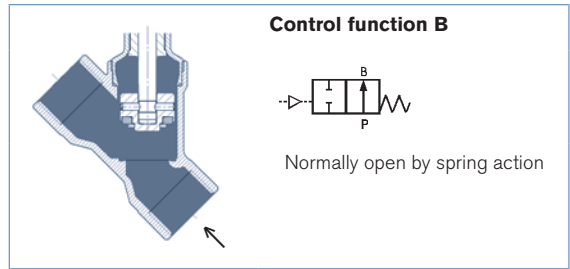
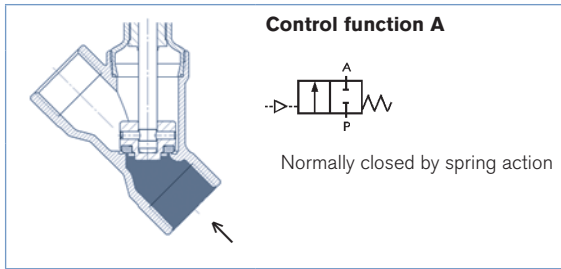

Orifice [mm]	Actuator size [mm]	Kv value water (m³/h)	Minimum pilot pressure CFA [bar]	Operating pressure up to +185°C CFA [bar]	Operating pressure up to +185°C CFB [bar]
15	50	5	5.2	25	16
	70	5	5.0	25	16
20	50	10	5.2	16	16
	70	11	5.0	20	16
25	50	15	5.2	9	14.5
	70	18	5.0	16	16
32	70	27	5.0	8.5	16
	90	28	5.0	16	16
40	70	38	5.0	6	16
	90	40	5.0	16	16
50	70	52	-	-	16
	90	55	5.0	10	16
	130	62	5.0	16	16
65	90	85	5.0	5	14
	130	95	5.6	16 (15*)	16 (15*)

* acc. to the Pressure Equipment Directive 97/23 / EC for compressible fluids in Group 1 (hazardous gases and vapors in accordance with Article 3, Section 1.3, letter a, first dash)

Flow rate: Kv value water [m³/h]: Measured at +20°C, 1 bar pressure at valve inlet and free outlet.

Pressure valves [bar]: Overpressure to the atmospheric pressure

Pressure charts with control function B and flow direction below the seat

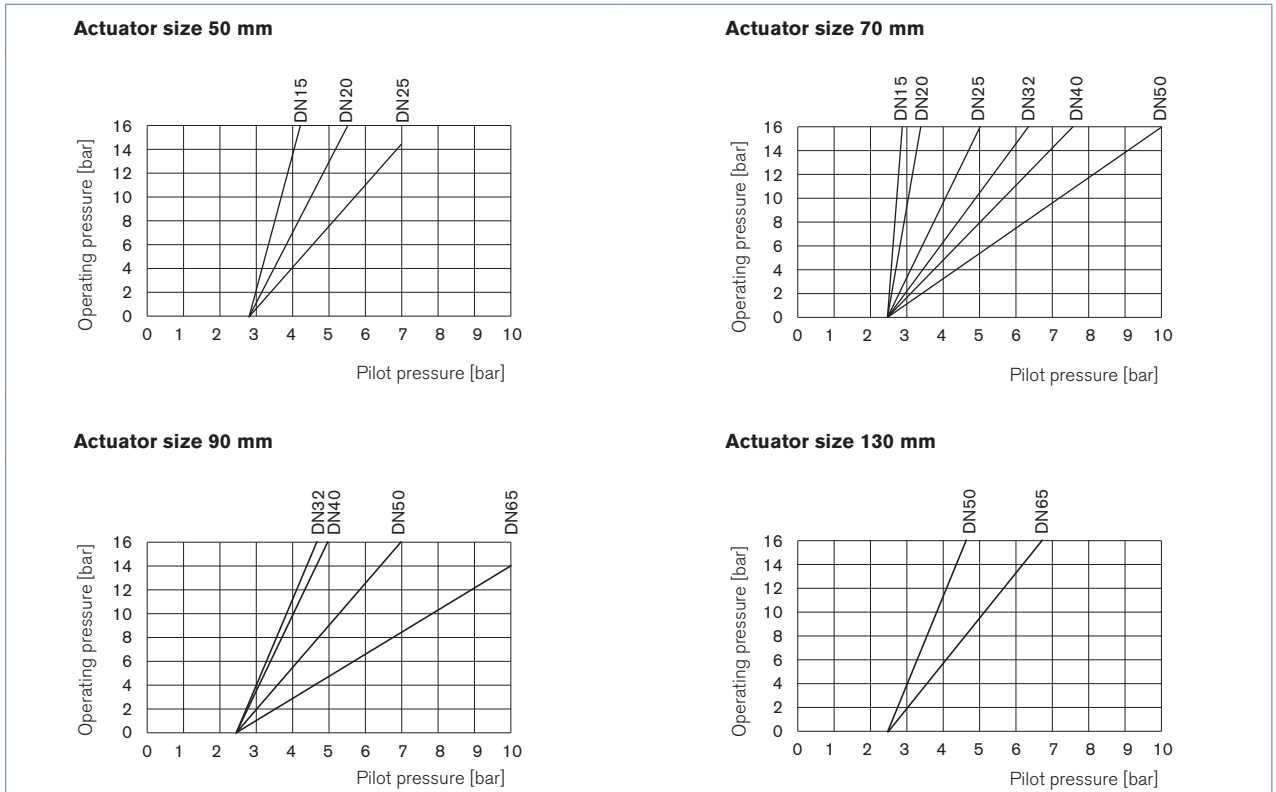

Ordering chart Type 2100, flow direction below the seat (for gases and liquids)

Weld end acc. to EN ISO 1127/ISO 4200, flow direction below the seat

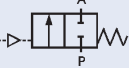
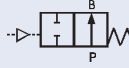
Control function	Orifice (mm)	Actuator size ϕ [mm]	Port connection tube ϕ [mm]	Minimum pilot pressure [bar]	Operating pressure up to +185°C [bar]	Item no.	Item no. certified Atex II 2GD Mechanical
A 2/2-way valve, NC 	15	50	21.3 x 1.6	5.2	25	187 065	259 581
		70	21.3 x 1.6	5.0	25	188 680	259 582
	20	50	26.9 x 1.6	5.2	16	210 399	259 583
		70	26.9 x 1.6	5.0	20	188 681	259 584
	25	50	33.7 x 2	5.2	9	235 519	260 052
		70	33.7 x 2	5.0	16	188 682	260 053
	32	70	42.4 x 2	5.0	8.5	188 683	260 054
		90	42.4 x 2	5.0	16	188 684	260 055
	40	70	48.3 x 2	5.0	6	188 685	260 056
		90	48.3 x 2	5.0	16	188 686	260 058
	50	90	60.3 x 2	5.0	10	283500	283 502
		130	60.3 x 2	5.0	16	283 501	283 503
	65	90	76.1 x 2.3	5.0	5	239 459	260 061
		130	76.1 x 2.3	5.6	16 (15*)	239 475	260 066
B 2/2-way valve, NO 	15	50	21.3 x 1.6	see chart on p. 2	16	187 069	260 069
		70	21.3 x 1.6		16	188 697	260 074
	20	50	26.9 x 1.6		16	187 070	260 075
		70	26.9 x 1.6		16	188 698	260 085
	25	70	33.7 x 2		16	188 699	260 086
		70	42.4 x 2		16	188 700	260 087
	40	70	48.3 x 2		16	188 701	260 088
		70	60.3 x 2		16	283 504	283 505
	65	90	76.1 x 2.3		14	239 467	260 090
		130	76.1 x 2.3		16 (15*)	239 482	260 091

Weld end acc. to DIN 11850 S2, flow direction below the seat

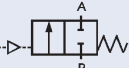
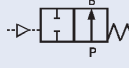
Control function	Orifice (mm)	Actuator size ϕ [mm]	Port connection tube ϕ [mm]	Minimum pilot pressure [bar]	Operating pressure up to +185°C [bar]	Item no.
A 2/2-way valve, NC 	15	50	19 x 1.5	5.2	25	187 071
		70	19 x 1.5	5.0	25	188 703
	20	50	23 x 1.5	5.2	16	227 605
		70	23 x 1.5	5.0	20	188 704
	25	50	29 x 1.5	5.2	9	227 606
		70	29 x 1.5	5.0	16	188 705
	32	70	35 x 1.5	5.0	8.5	188 706
		90	35 x 1.5	5.0	16	188 707
	40	70	41 x 1.5	5.0	6	188 708
		90	41 x 1.5	5.0	16	188 709
	50	90	53 x 1.5	5.0	10	188 710
		130	53 x 1.5	5.0	16	188 711
	65	90	70.0 x 2.0	5.0	5	239 460
		130	70.0 x 2.0	5.6	16 (15*)	237 020
B 2/2-way valve, NO 	15	50	19 x 1.5	see chart on p. 2	16	187 075
		70	19 x 1.5		16	188 720
	20	50	23 x 1.5		16	187 076
		70	23 x 1.5		16	188 721
	25	70	29 x 1.5		16	188 722
		70	35 x 1.5		16	188 723
	40	70	41 x 1.5		16	188 724
		70	53 x 1.5		16	188 725
	65	90	70.0 x 2.0		14	239 468
		130	70.0 x 2.0		16 (15*)	239 483

* acc. to the Pressure Equipment Directive 97/23 / EC for compressible fluids in Group 1 (hazardous gases and vapors in accordance with Article 3, Section 1.3, letter a, first dash)

 Further versions on request

 Control function
I (double-acting)

Ordering chart Type 2100, flow direction below the seat (for gases and liquids), *continued*

Weld end acc. to ASME BPE, flow direction below the seat

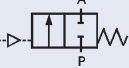
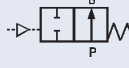
Control function	Orifice (mm)	Actuator size \varnothing [mm]	Port connection tube \varnothing [mm]	Minimum pilot pressure [bar]	Operating pressure up to +185°C [bar]	Item no.	
A 2/2-way valve, NC 	15	50	12.7 x 1.65	5.2	25	187 077	
		70	12.7 x 1.65	5.0	25	188 726	
	20	50	19.05 x 1.65	5.2	16	227 607	
		70	19.05 x 1.65	5.0	20	188 727	
	25	50	25.4 x 1.65	5.2	9	227 608	
		70	25.4 x 1.65	5.0	16	188 728	
	40	70	38.1 x 1.65	5.0	6	188 729	
		90	38.1 x 1.65	5.0	16	188 730	
	50	90	50.8 x 1.65	5.0	10	188 731	
		130	50.8 x 1.65	5.0	16	188 732	
	65	90	63.5 x 1.65	5.0	5	239 461	
		130	63.5 x 1.65	5.6	16 (15*)	239 478	
	B 2/2-way valve, NO 	15	50	12.7 x 1.65	see chart on p. 2	16	187 082
			70	12.7 x 1.65		16	188 740
20		50	19.05 x 1.65	16		187 083	
		70	19.05 x 1.65	16		188 741	
25		70	25.4 x 1.65	16		188 742	
		40	70	38.1 x 1.65		16	188 781
50		70	50.8 x 1.65	16		188 744	
		65	90	63.5 x 1.65		14	239 469
130		63.5 x 1.65	16 (15*)	239 484			

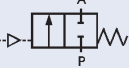
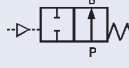

Weld end acc. to SMS 3008, flow direction below the seat

Control function	Orifice (mm)	Actuator size \varnothing [mm]	Port connection tube \varnothing [mm]	Minimum pilot pressure [bar]	Operating pressure up to +185°C [bar]	Item no.	
A 2/2-way valve, NC 	15	50	12 x 1.0	5.2	25	187 084	
		70	12 x 1.0	5.0	25	188 745	
	20	50	18 x 1.0	5.2	16	227 609	
		70	18 x 1.0	5.0	20	188 746	
	25	50	25 x 1.2	5.2	9	227 610	
		70	25 x 1.2	5.0	16	188 747	
	40	70	38 x 1.2	5.0	6	188 748	
		90	38 x 1.2	5.0	16	188 749	
	50	90	51 x 1.2	5.0	10	188 750	
		130	51 x 1.2	5.0	16	188 751	
	65	90	63.5 x 1.65	5.0	5	239 462	
		130	63.5 x 1.65	5.6	16 (15*)	239 477	
	B 2/2-way valve, NO 	15	50	12 x 1.0	see chart on p. 2	16	187 089
			70	12 x 1.0		16	188 759
20		50	18 x 1.0	16		187 090	
		70	18 x 1.0	16		188 760	
25		70	25 x 1.2	16		188 761	
		40	70	38 x 1.2		16	188 762
50		70	51 x 1.2	16		188 763	
		65	90	63.5 x 1.65		14	239 470
130		63.5 x 1.65	16 (15*)	239 485			

* acc. to the Pressure Equipment Directive 97/23 / EC for compressible fluids in Group 1 (hazardous gases and vapors in accordance with Article 3, Section 1.3, letter a, first dash)

Ordering chart Type 2100, flow direction below the seat (for gases and liquids), *continued*

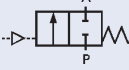
Weld end acc. to BS 4825, flow direction below the seat

Control function	Orifice (mm)	Actuator size \varnothing [mm]	Port connection tube \varnothing [mm]	Minimum pilot pressure [bar]	Operating pressure up to +185°C [bar]	Item no.	
A 2/2-way valve, NC 	15	50	12.7 x 1.2	5.2	25	187 091	
		70	12.7 x 1.2	5.0	25	188 764	
	20	70	19.05 x 1.65	5.0	20	188 765	
		70	25.4 x 1.65	5.0	16	188 728	
		70	38.1 x 1.65	5.0	6	188 729	
		90	38.1 x 1.65	5.0	16	188 730	
		50	90	50.8 x 1.65	5.0	10	188 731
		65	130	50.8 x 1.65	5.0	16	188 732
			90	63.5 x 1.65	5.0	5	239 461
		130	63.5 x 1.65	5.6	16 (15*)	239 478	
B 2/2-way valve, NO 	15	50	12.7 x 1.2	see chart on p. 2	16	187 095	
		70	12.7 x 1.2		16	188 778	
	20	50	19.05 x 1.65		16	187 096	
		70	19.05 x 1.65		16	188 779	
	25	70	25.4 x 1.65		16	188 742	
		40	70		38.1 x 1.65	16	188 781
	50	70	50.8 x 1.65		16	188 744	
		65	90		63.5 x 1.65	14	239 469
	130		63.5 x 1.65		16 (15*)	239 484	

* acc. to the Pressure Equipment Directive 97/23 / EC for compressible fluids in Group 1 (hazardous gases and vapors in accordance with Article 3, Section 1.3, letter a, first dash)

Technical data angle seat valve Type 2100 flow direction above the seat (for gases and steam)

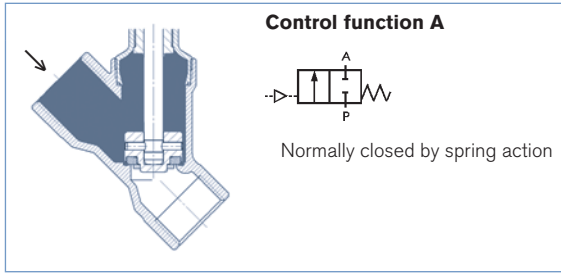

Attention!

Valves with flow above the seat are only conditionally usable for liquid medium. There is a danger of waterhammer!

Orifice [mm]	Actuator size [mm]	Kv value water (m³/h)	Operating pressure up to +185°C CFA [bar]
15	50	5	16
	70	5.1	16
20	50	10	16
	70	12	16
25	50	15	16
	70	19	16
32	70	28	16
40	70	38	16
	90	40	16
50	70	50	12
	90	55	16

Flow rate: Kv value water [m³/h]: Measured at +20°C, 1 bar pressure at valve inlet and free outlet.

Pressure valves [bar]: Overpressure to the atmospheric pressure

Pressure charts with control function A and flow direction above the seat

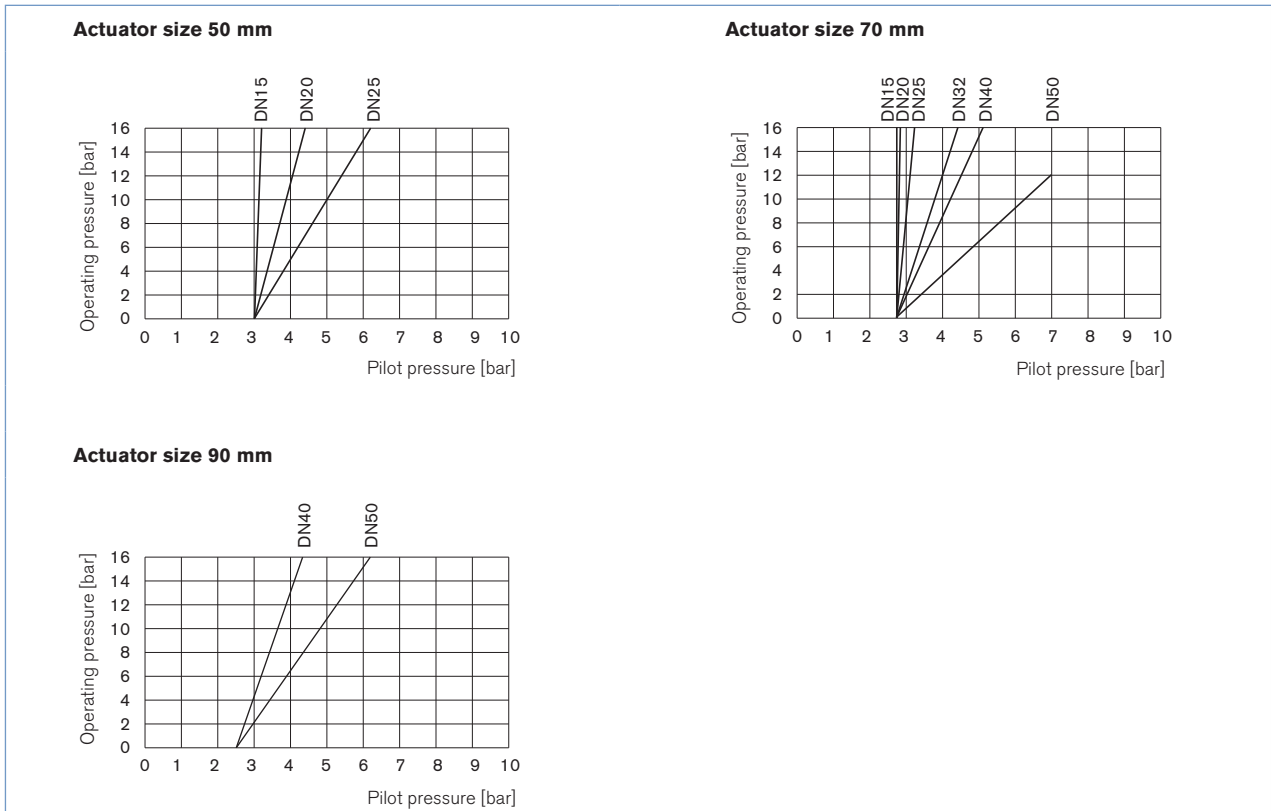

Ordering chart Type 2100 flow direction above the seat (for gases and steam)

Weld end acc. to EN ISO 1127/ISO 4200, flow direction above the seat

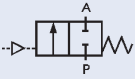
Control function	Orifice (mm)	Actuator size \varnothing [mm]	Port connection tube \varnothing [mm]	Minimum pilot pressure [bar]	Operating pressure up to +185°C [bar]	Item no.
A 2/2-way valve. NC 	15	50	21.3 x 1.6	see chart on p. 6	16	187 066
	20	50	26.9 x 1.6		16	187 067
	25	50	33.7 x 2		16	187 068
	32	70	42.4 x 2		16	188 692
	40	70	48.3 x 2		16	188 693
	50	70	60.3 x 2.0		12	274 663

Weld end acc. to DIN 11850 S2, flow direction above the seat

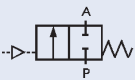
Control function	Orifice (mm)	Actuator size \varnothing [mm]	Port connection tube \varnothing [mm]	Minimum pilot pressure [bar]	Operating pressure up to +185°C [bar]	Item no.
A 2/2-way valve. NC 	15	50	19 x 1.5	see chart on p. 6	16	187 072
	20	50	23 x 1.5		16	187 073
	25	50	29 x 1.5		16	187 074
	32	70	35 x 1.5		16	188 715
	40	70	41 x 1.5		16	188 716
	50	70	53 x 1.5		12	188 718

Weld end acc. to ASME BPE, flow direction above the seat

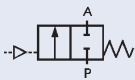
Control function	Orifice (mm)	Actuator size \varnothing [mm]	Port connection tube \varnothing [mm]	Minimum pilot pressure [bar]	Operating pressure up to +185°C [bar]	Item no.
A 2/2-way valve. NC 	15	50	12.7 x 1.65	see chart on p. 6	16	187 078
	20	50	19.05 x 1.65		16	187 079
	25	50	25.4 x 1.65		16	187 080
	40	70	38.1 x 1.65		16	188 736
	50	70	50.8 x 1.65		12	188 738

Weld end acc. to SMS 3008, flow direction above the seat

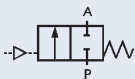
Control function	Orifice (mm)	Actuator size \varnothing [mm]	Port connection tube \varnothing [mm]	Minimum pilot pressure [bar]	Operating pressure up to +185°C [bar]	Item no.
A 2/2-way valve. NC 	15	50	12 x 1.0	see chart on p. 6	16	187 085
	20	50	18 x 1.0		16	187 086
	25	50	25 x 1.2		16	187 087
	40	70	38 x 1.2		16	188 755
	50	70	51 x 1.2		12	188 757

Ordering chart Type 2100 flow direction above the seat (for gases and steam), *continued*

Weld end acc. to BS 4825, flow direction above the seat

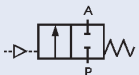
Control function	Orifice (mm)	Actuator size Ø [mm]	Port connection tube Ø [mm]	Minimum pilot pressure [bar]	Operating pressure up to +185°C [bar]	Item no.
A 2/2-way valve. NC 	15	50	12.7 x 1.2	see chart on p. 6	16	187 092
	20	50	19.05 x 1.65		16	187 093
	25	50	25.4 x 1.65		16	187 080
	40	70	38.1 x 1.65		16	188 736
	50	70	50.8 x 1.65		12	188 738

Materials angle seat valve Type 2100

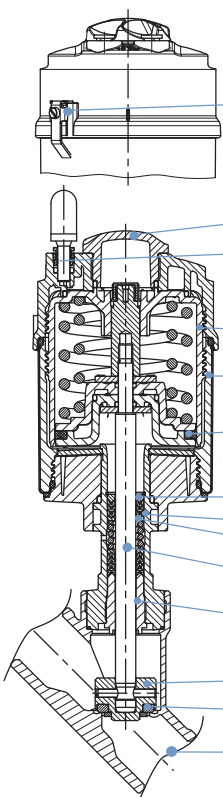
	A Ground terminal	Stainless steel 1.4301/1.4305 <i>Only for the ATEX version</i>
	1 Optical position indicator	Transparent cap polysulfone PSU
	2 Pilot air ports	Push-in connector PP (standard) <i>On request:</i> Thread G1/8" stainless steel 1.4305
	3 Actuator	PPS
	4 Cover	Stainless steel 1.4561 (316Ti)
	5 Piston seal	FKM
	6 Spring	Stainless steel 1.4310
	7 Pipe	Stainless steel 1.4401 (316)/1.4404 (316L)
	8 Spindle packing	PTFE
	9 Spindle	Stainless steel 1.4401 (316)/1.4404 (316L)
	10 Spindle guide	PEEK
	11 Swivel plate	Stainless steel 1.4401 (316)/1.4404 (316L)
	12 Seals	PTFE
	13 Valve body	EN ISO 1127/ISO4200 and DIN 11850 S2 ASME BPE, SMS 3008 and BS 4825 Part 1 Stainless steel 316L

Lubricants for spindle packing and actuator are classified according NSF H1

Dimensions angle seat valve Type 2100 [mm]

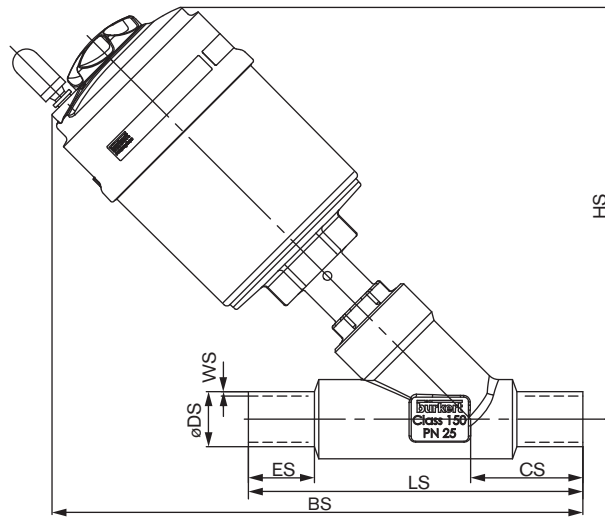

ISO 4200, SMS 3008

All bodies			acc. to ISO 4200						acc. to SMS 3008					
Orifice [mm]	Actuator size [mm]	HS	BS	CS	LS	øDS	ES	WS	BS	CS	LS	øDS	ES	WS
15	50	163	200	34	100	21.3	20	1.6	212	46	135	12	30	1
	70	178	216						228					
20	50	171	212	39	115	26.9	25	1.6	225	52	145	18	30	1
	70	186	228						241					
25	50	172	218	43	130	33.7	30	2	226	51	152	25	30	1.2
	70	188	234						242					
32	70	197	241	40	145	42.4	26	2	241	40	145	38	26	1.2
	90	242	283						283					
40	70	201	253	49	160	48.3	30	2	264	60	182	38	30	1.2
	90	245	296						307					
	130	296	345						356					
50	70	219	273	50	175	60.3	30	2.0	287	64	210	51	30	1.2
	90	261	312						326					
	130	312	362						376					
65	90	273	324	50	210	76.1	26	2.3	330	56	230	63.5	26	1.65
	130	324	374						380					

DIN 11850 S2, ASME BPE, BS 4825

All bodies			acc. to DIN 11850 S2						acc. to ASME BPE						acc. to BS 4825					
Orifice [mm]	Actuator size [mm]	HS	BS	CS	LS	øDS	ES	WS	BS	CS	LS	øDS	ES	WS	BS	CS	LS	øDS	ES	WS
15	50	163	200	34	100	19	20	1.5	200	34	100	12.7	15	1.65	200	34	100	12.7	20	1.2
	70	178	216						216						216					
20	50	171	212	39	115	23	25	1.5	212	39	115	19.05	25	1.65	212	39	115	19.05	25	1.2
	70	186	228						228						228					
25	50	172	218	43	130	29	26	1.5	218	43	130	25.4	30	1.65	218	43	130	25.4	30	1.65
	70	188	234						234						234					
32	70	197	241	40	145	35	26	1.5	-	-	-	-	-	-	-	-	-	-	-	-
	90	242	283						-						-					
40	70	201	253	49	160	41	26	1.5	253	49	160	38.1	30	1.65	253	49	160	38.1	30	1.65
	90	245	296						296						296					
	130	296	345						345						345					
50	70	219	273	50	175	53	26	1.5	273	50	175	50.8	30	1.65	273	50	175	50.8	30	1.65
	90	261	312						312						312					
	130	312	362						362						362					
65	90	273	324	50	210	70	26	2	330	56	230	63.5	26	1.65	330	56	230	63.5	26	1.65
	130	324	374						380						380					

Dimensions for valve system On/Off ELEMENT Type 8801-YE [mm]

Dimensions valve system On/Off ELEMENT Type 8801-YE-K (with pneumatic control unit Type 8690)

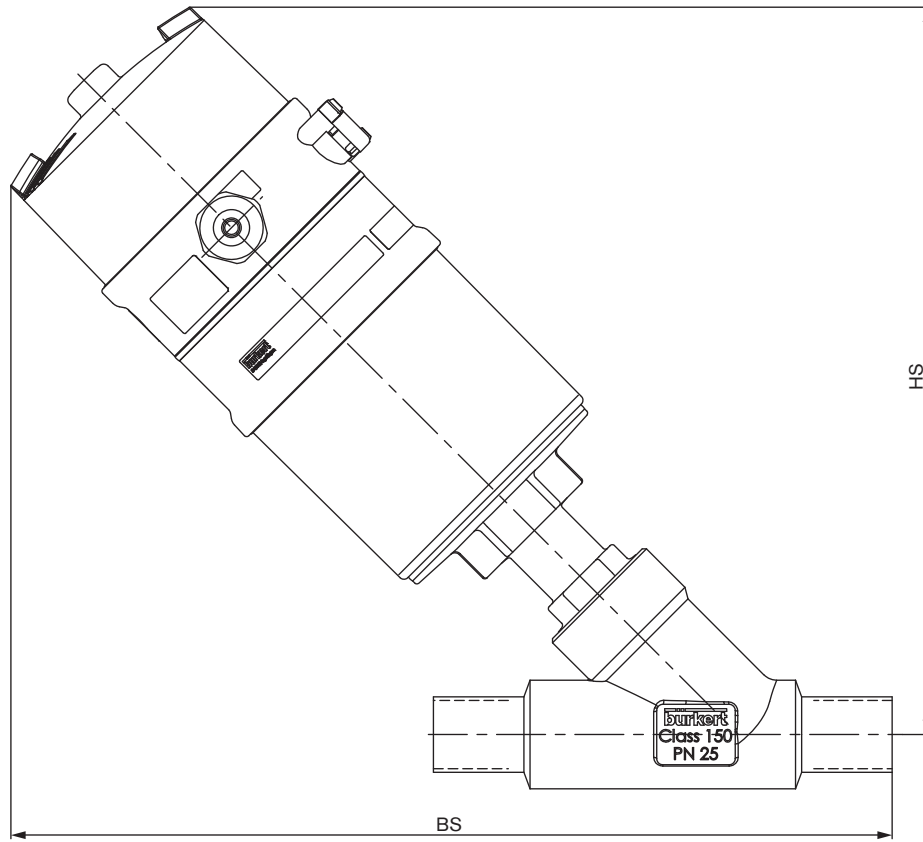

Orifice [mm]	Actuator size [mm]	HS	BS acc. to ISO 4200, DIN 11850 S2, ASME BPE, BS 4825	BS acc. to SMS 3008
15	70	232	270	282
20	70	240	282	295
25	70	242	288	296
32	70	251	295	295
	90	294	335	335
40	70	255	307	318
	90	297	348	359
	130	334	383	394
50	70	273	327	341
	90	313	364	348
	130	350	400	414
65	90	325	376	382
	130	362	412	418

Further dimensions see p. 9

Dimensions for valve system On/Off ELEMENT Type 8801-YE [mm]

Dimensions valve system On/Off ELEMENT Type 8801-YE-K (with pneumatic control unit Type 8697)

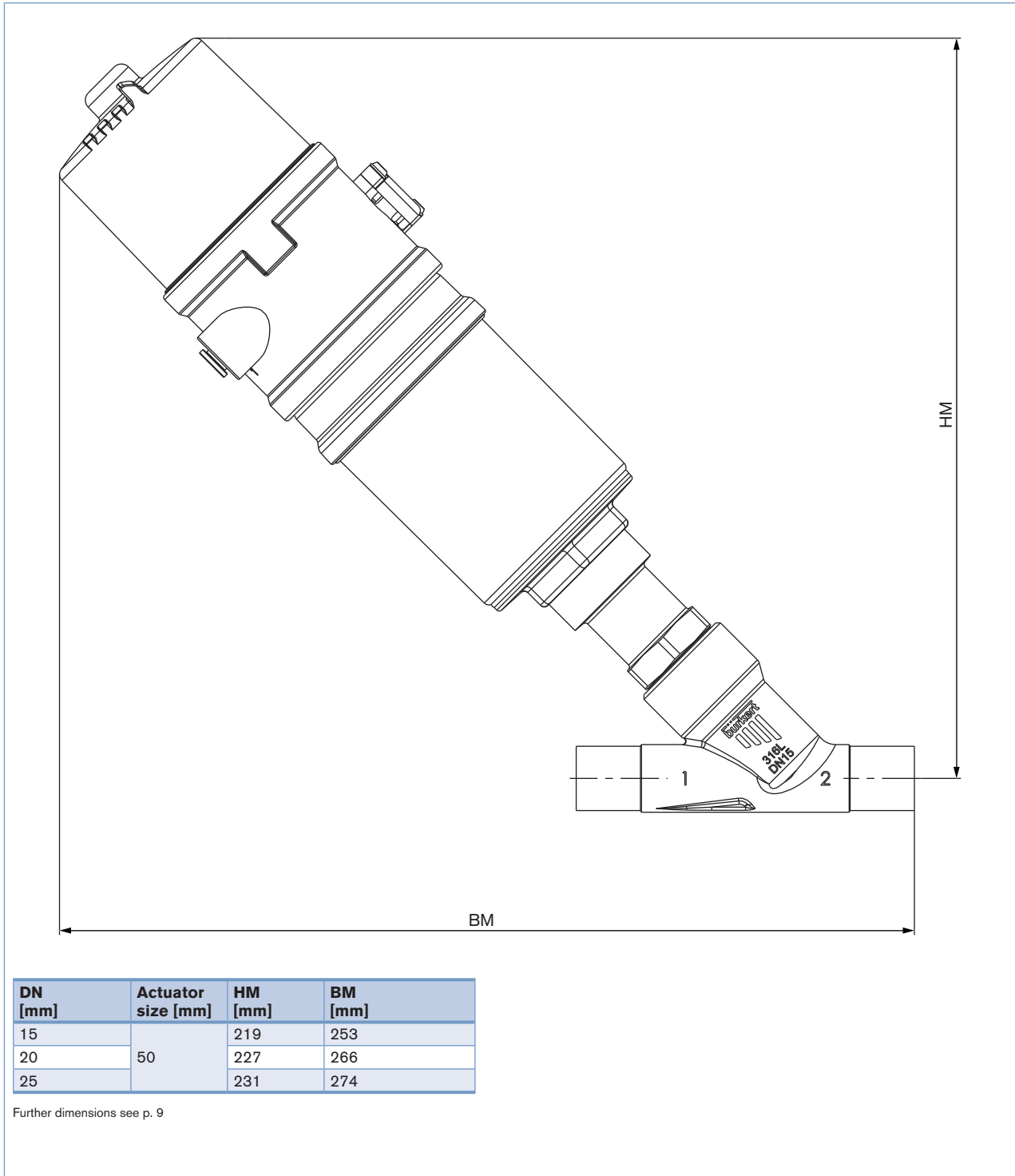

Dimensions for valve system On/Off ELEMENT Type 8801-YE [mm], *continued*

Dimensions valve system On/Off ELEMENT Type 8801-YE-H (*with control head Type 8691*)

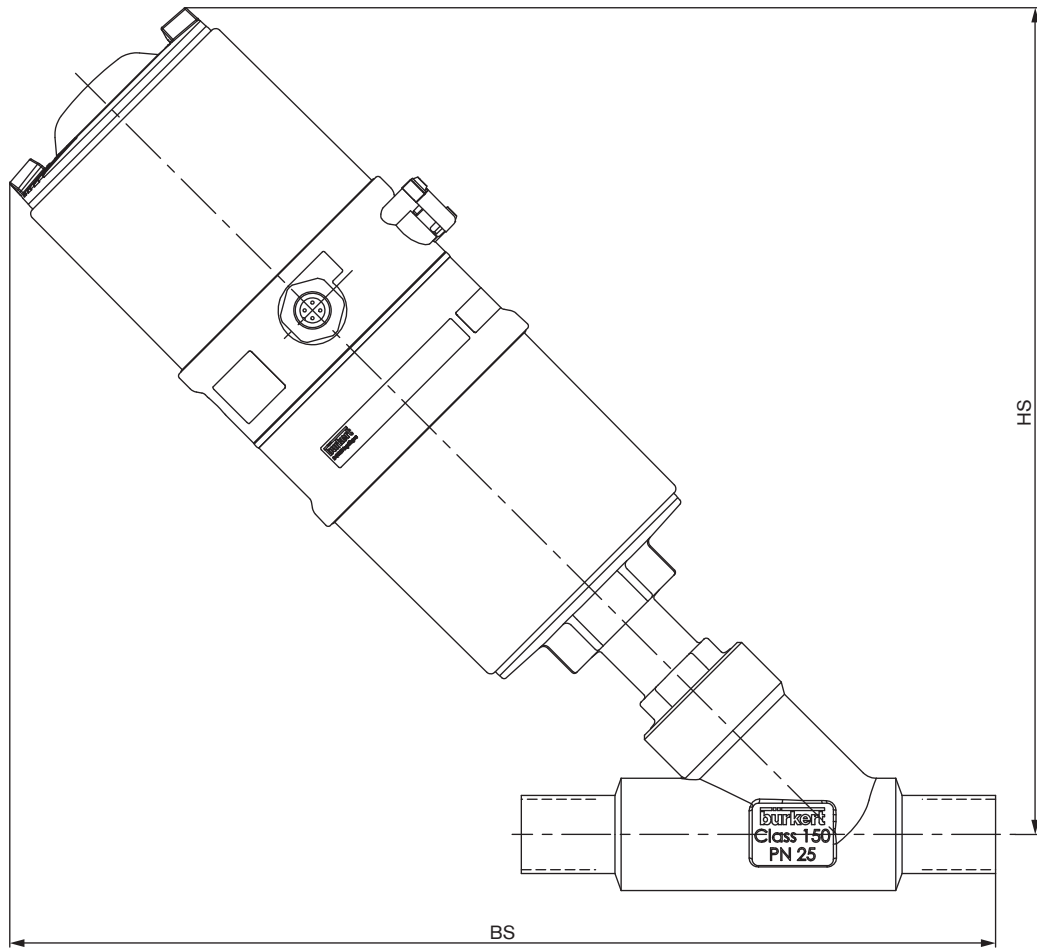

Orifice [mm]	Actuator size [mm]	HS	BS acc. to ISO 4200, DIN 11850 S2, ASME BPE, BS 4825	BS acc. to SMS 3008
15	70	256	294	306
20	70	264	306	319
25	70	266	312	320
32	70	275	319	319
	90	318	359	359
40	70	279	331	342
	90	321	372	383
	130	358	407	418
50	70	297	351	365
	90	337	388	402
	130	374	424	438
65	90	349	400	406
	130	386	436	442

Further dimensions see p. 9

Dimensions for valve system On/Off ELEMENT Type 8801-YE [mm], *continued*

Dimensions valve system On/Off ELEMENT Type 8801-YE-M (with control head Type 8695)

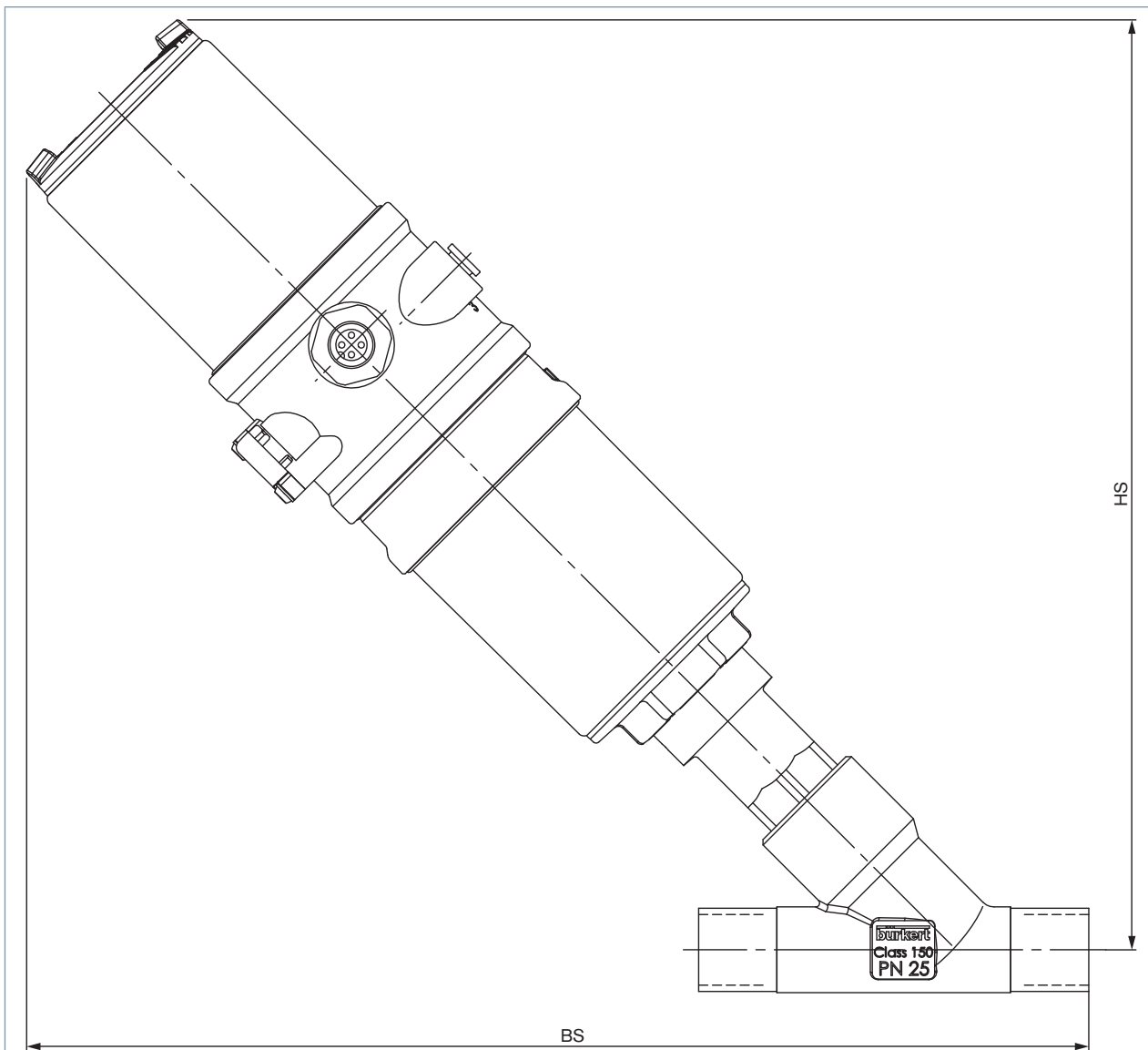

Orifice [mm]	Actuator size [mm]	HS	BS acc. to ISO 4200, DIN 11850 S2, ASME BPE, BS 4825	BS acc. to SMS 3008
15	50	239	276	288
20	50	247	288	301
25	50	248	294	302

Further dimensions see p. 9