

3/2-way Seat Valve, for media up to +180 °C, DN15-50



- Ultra compact version
- Long service life
- Valve body in gunmetal
- Various fluidic circuit and actuator control functions

Type 2002 can be combined with...



Type 8697
Electrical position feedback



Type 6012/6014 P
Pilot valve

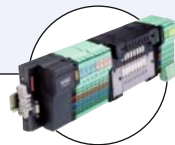

Type 8640/8644
Valve block



Type 5470
Solenoid valve

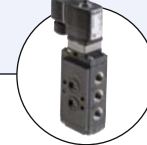

Type 6519 NAMUR

The pneumatically operated 3/2-way valve is operated with a piston actuator. The standard actuator material is PA. For high ambient temperatures (eg external sterilization) PPS is available on request for temperatures up to 140°. High flow rates are attained with the gunmetal 3-way body. The reliable self-adjusting packing gland provides high sealing integrity.

Various fluidic circuit functions can be obtained by a simple exchange of the pressure and service ports.

These maintenance-free and robust valves can be retro-fitted with a comprehensive range of accessories for position indication or manual override.

■ **Note:** For PA actuators in the sizes 50 and 63, the combination of max. media temperature and max. ambient temperature is as shown in the following chart:

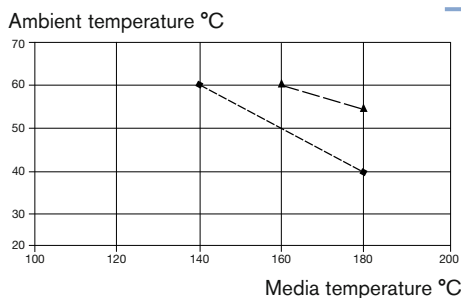

Technical data	
Orifice	DN 15 - 50
Body materials	Gunmetal
Actuator material	PA (PPS on request)
Seal material	PTFE
Media	Water, alcohol, oils, fuels, hydraulic fluid, alkaline solutions, salt solution, organic solutions, hot water, steam
Viscosity	Max. 600 mm ² /s
Packing gland (with silicone grease)	PTFE V-rings with spring compensation
Media temperature ■	-10 to +180 °C
Ambient temperature	
PA actuator ■	-10 to +60 °C
PPS actuator	
Actuator sizes Ø 50-80	+5 to +140 °C
Actuator sizes Ø 100-125	+5 to +90 °C, (up to 140 °C for a short period)
Installation	As required, preferably with actuator in upright position
Control medium	Neutral gases, air
Max. pilot pressure	10 bar 7 bar with actuator Ø 125
Port connections	Threaded port ISO228

Ordering chart for valves with port 1 closed by spring action (other versions on request)

Control function	Port connection	Orifice [mm]	Actuator size Ø [mm]	Kv value water [m³/h]		Min. pilot pressure [bar]	Max. operating pressure to 180°C [bar]		Weight	Item no. PA actuator
				1 → 2	2 → 3		1 → 2	2 → 3 2 → 1		
A 3/2-way, normally closed (NC) (port 1)	G 1/2	15	50	7	4.5	4.4	11	16	1.3	002 131
			63	9	5.5	4.7	16	16	1.6	002 300
	G 3/4	20	50	8.9	6.3	4.4	11	16	1.3	002 132
			63	10.5	6.5	4.7	16	16	1.6	002 301
	G 1	25	63	17	11	4.9	10	16	2.1	002 133
	G 1 1/4	32	80	32	22	6.0	9	16	4.3	002 134
			125	38	24	3.4	14	16	8.1	002 302
	G 1 1/2	40	80	34	24	6.0	9	16	4.3	002 135
			125	40	26	3.4	14	16	8.1	002 303
	G 2	50	125	55	37	4.3	10	16	9.5	002 136

i Further versions on request



Materials
Actuator in PPS



Control functions
Normally open (B), Double-acting (I)



Approvals
GL

Pilot pressure chart (CFA, flow direction 3 → 2)

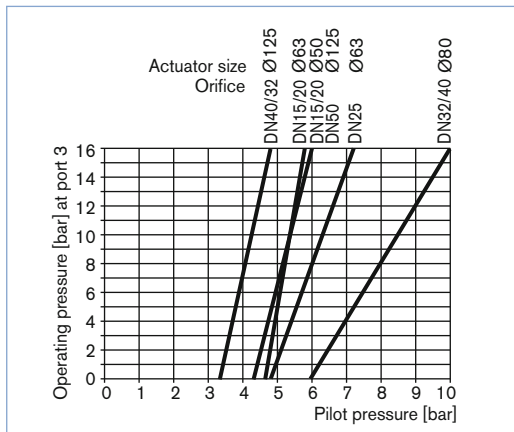

Ordering chart for accessories

3/2-way pilot valves with banjo bolts

Seal material valve FKM, seal material banjo bolt NBR

Valve for actuator size [Ø mm]	Type	Pressure inlet P (valve body)	Service port A (banjo bolt)	Orifice [mm]	Qn value air [l/min]	Pressure range [bar]	Electrical coil connection Ind. Std.	Power consumption [W]	Item no. Voltage/frequency [V/Hz] 024/DC 230/50
50-63	6012P	Tube fitting Ø 6 mm	G 1/4	1.2	48	0-10	Form B	4	552 283 552 286
50-125	6014P	G 1/4	G 1/4	2	120	0-10	Form A	8	424 103 424 107

Cable plug Type 2507, Form B or Type 2508, Form A

	Item no.
Type 2507, Form B Industrial standard, 0 to 250 V without circuitry (Type 6012 P)	423 845
Type 2508, Form A acc. DIN EN 175301-803, 0 to 250 V without circuitry (Type 6014 P, Type 0331P)	008 376

For further accessories see Type 1062, page 238 or the accessories datasheet Type 2XXX for the full options programme.

Note: For design reasons, some of the accessories cannot be supplied for actuator size Ø 40 mm. Please request the accessories datasheet Type 2XXX.

Materials

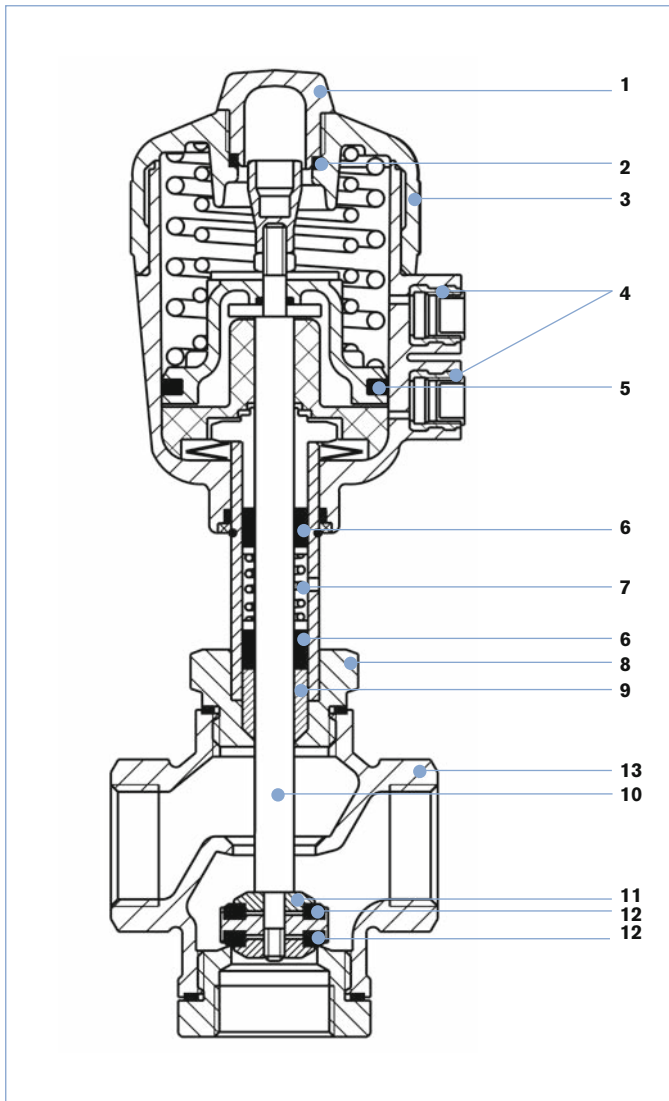

Description	Material
1 Transparent cap	Polycarbonate (PC)
2 O-Ring	FKM
3 Actuator	Polyamide (PA)
4 Pilot air ports G 1/4	Brass
5 Cylinder seal	NBR
6 V-seals	PTFE
7 Tension spring	1.4310
8 Nipple	Brass CuZn
9 Wiper	PTFE
10 Spindle	1.4401
11 Plug	CuZn36Pb1.5
12 Seals	PTFE
13 Valve body	Gunmetal G-CuSn5ZnPb2%Ni

Connections for fluidic circuit functions C, D, E and F

Actuator with control function A
When de-energised port connection 1 is closed with spring

Fluidic circuit function	Connection - port		
	1	2	3
C	P	A	R
D	R	A	P
E	P1	A	P2
F	A	P	B

A, B service ports
P, P1, P2 pressure ports
R exhaust port

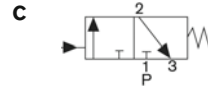
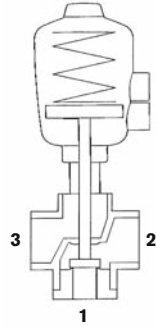

When de-energised, pressure port 1 closed, service port 2 exhausted

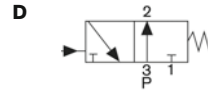

When de-energised, pressure port 3 connected to service port 2, exhaust port 1 closed

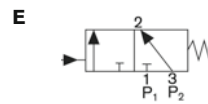

Mixer valve
When de-energised, pressure port 3 connected to service port 2, pressure port 1 closed

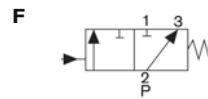

Distributor valve
When de-energised, pressure port 2 connected to service port 3, service port 1 closed

Dimensions [mm]

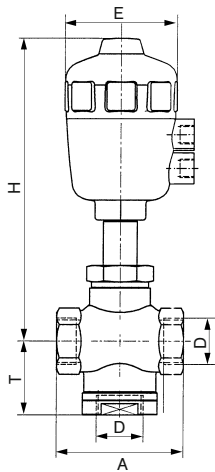

Orifice	Actuator size Ø	Port connection D	A	E	H	T
15	50	G 1/2	75	64	179	49
	63	G 1/2	75	80	213	49
20	50	G 3/4	75	64	179	49
25	63	G 1	90	80	216	52.5
32	80	G 1 1/4	120	101	237	66
	125	G 1 1/4	120	153	336	66
40	80	G 1 1/2	120	101	237	66
	125	G 1 1/2	120	153	336	66
50	125	G 2	160	153	350	85