





SKU: GV5194

-  VOLT Bronze Screwed Globe Valve - SDNR
-  VOLT Bronze -Gewindedurchgangsventil - SDNR
-  VOLT Válvula de globo de bronce atornillada - SDNR
-  VOLT Bronze Screwed Globe Valve - SDNR

Valves[™]
O N L I N E

- 1/2" - 2" Screwed Bronze Globe Valve.
- 1/2" - 2" Verschraubt Bronze Absperrventil .
- 1/2" - 2" Atornillada Válvula Globo bronce
- 1/2" - 2" Vissée Bronze Vanne

Screwed Bronze Globe Valve SDNR



- **PN16 Rated**
- **Screw Down Non Return**
- **Handwheel Operated**
- **Fluids: Air, Gas, Oil & Water**

Description:
Hand Wheel Operated Cast Globe
Valve in Bronze.
Integral PTFE Seat,
Screwed BSPP Female
Cast Handwheel,
Rated PN16,
Temperature -10°C to 180°C.



Description

Cast bronze globe valve. Screwed BSPP , . Handwheel operated. Suitable for applications where isolation of gases and liquids are required. Integral seat PTFE, Screw Down Non Return
PN16
Temperature Max 180° C (see chart)



Beschreibung

Bronzeguss Kugelventil . Verschraubt BSPP , . Handrad betätigt . Geeignet für Anwendungen, in denen Isolierung von Gasen und Flüssigkeiten erforderlich sind. Integral Sitz PTFE, verschraubte Non Return
PN16
Max Temperatur 180 ° C (siehe Tabelle)







Descripción

Fundido en bronce válvula de globo . Screwed BSPP , . Volante operado . Adecuado para aplicaciones donde se requiere aislamiento de gases y líquidos . PTFE asiento Integral, de rosca no retorno
PN16
Temperatura máxima de 180 ° C (véase el gráfico)



Description

Cast robinet à soupape bronze. Vissée BSPP , . Volant exploité . Convient pour les applications où l'isolement des gaz et liquides sont nécessaires. PTFE de siège intégré, vissée de non-retour
PN16
Température max 180 ° C (voir tableau)

-  VOLT Bronze Screwed Globe Valve - SDNR
-  VOLT Bronze -Gewindedurchgangsventil - SDNR
-  VOLT Válvula de globo de bronce atornillada - SDNR
-  VOLT Bronze Screwed Globe Valve - SDNR

Bronze Screwed Globe Valve – SDNR

Material List

Description	Material
Body	Bronze
Stem	Brass
Seat	PTFE
Handwheel	Cast

Press. Temp

Pressure	PN16
Temperature	180°C

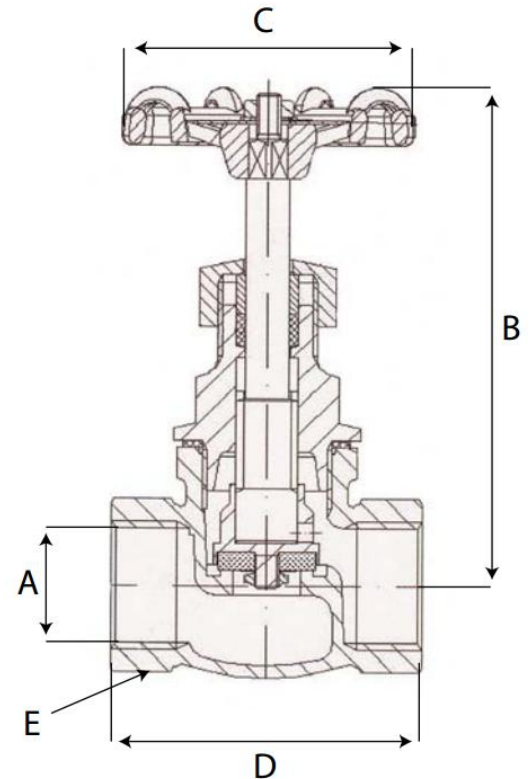

DIMENSIONS

A BSPP	B	C	D	E	Kg
1/2"	80	50	60	CH27	0.42
3/4"	86	55	70	CH33	0.6
1"	96	70	80	CH41	0.92
1 1/4"	110	80	96	CH50	1.3
1 1/2"	115	80	105	CH58	1.65
2"	128	110	130	CH58	2.65